



EZ Wireless 4K HDMI Extenders ECW-200 & EHW-200



User Manual
Version 1.0

Thank You for Purchasing This Product

For optimum performance and safety, please read these instructions carefully before connecting, operating or adjusting this product. Please keep this manual for future reference.

Surge Protection Device Recommended

This product contains sensitive electrical components that may be damaged by electrical spikes, surges, electric shock, lightning strikes, etc. Use of surge protection systems is highly recommended in order to protect and extend the life of your equipment.

Table of Contents

| Section and Topic | Page |
|---|-------------|
| 1. Introduction..... | 1 |
| 2. Features..... | 2 |
| 3. Specifications..... | 2 |
| 4. Package Contents..... | 3 |
| 5. Device Layout..... | 3 |
| 6. LED Meanings..... | 4 |
| 7. Operation Instructions..... | 5 |
| 8. Pairing a New Extra Transmitter..... | 6 |
| 9. How to Un-Pair TX from RX (A) and Re-Pair to RX (B)..... | 6 |
| 10. Adding a Custom Background Image..... | 7 |
| 11. FCC Warning..... | 8 |

1. Introduction

Transmit video signals wirelessly to TVs or monitors from a variety of sources. Compatible with any HDMI or USB-C equipped device. These devices transmit video signals by creating their own wifi signal, negating the need to connect to an established network. There are also no drivers or extra software to install, simply plug and play. This pocket sized transmitter and receiver kit is portable and lightweight, making it easy to transmit and cast your screen on the go. Transmit videos, games, presentations and more from all of your devices. Works perfectly with Windows, MacOS, Android and iOS, supporting USB-C or HDMI.



2. Features

- 🌀 True 4K wireless transmission
- 🌀 Watch everything on a bigger screen
- 🌀 Plug and play operation, with no extra software or driver installations
- 🌀 Impressive OS and port compatibility
- 🌀 Excellent dynamic and static video quality
- 🌀 Supports up to eight transmitters to one receiver
- 🌀 Transmission distances up to 50 meters (with clear line of sight)
- 🌀 Auto pair and connection & auto channel selection

3. Specifications

| | |
|--|---|
| Video Input | Up to 4K 30Hz |
| Video Output | Up to 4K 60Hz |
| Audio | Stereo 16bit 48KHz |
| Wireless Channel | IEEE 802.11ac, 5GHz |
| Antenna | 2T2R |
| Latency | ~ 90-120ms |
| HDMI Version | HDMI 2.0 |
| USB and DisplayPort Version | USB Type-C 3.2 Gen 2 & DP 1.4a |
| HDCP Version | HDCP 2.2 |
| Authentication Protocol | WPA2 (WPA-PSK / WPA2-Enterprise) |
| Security | AES 128bit |
| Platforms Supported | Any device with HDMI input |
| Transmission Distance | Up to 50 meters (with clear line of sight) |
| Power Consumption | ~ 5W |
| Weight | 58g |
| Power Supply | USB Type-C 5V / 1A (Cable[s] Included) |
| Dimensions | 192.5 x 36.6 x 15.2mm |

4. Package Contents

Before using this unit, please check the packaging and make sure the following items are contained in the shipping carton:

- 🌀 Transmitter.....(1 piece)
- 🌀 Receiver.....(1 piece)
- 🌀 USB-C to USB-A Cable.....(1-2 pieces depending on model)
- 🌀 USB Y Cable.....(1 piece)
- 🌀 User Manual.....(1 piece)

5. Device Layout

Transmitters - Easily mirror whatever shows on your laptop or mobile screen.

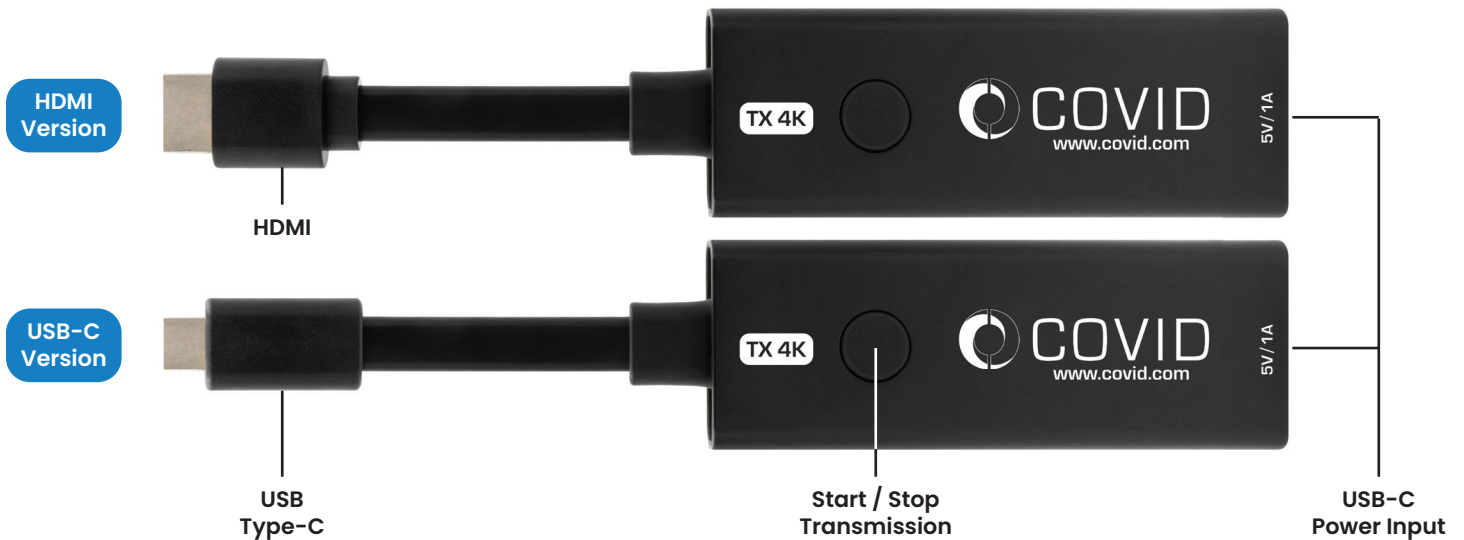

Receiver - Display the signal passed from your transmitter on the screen.

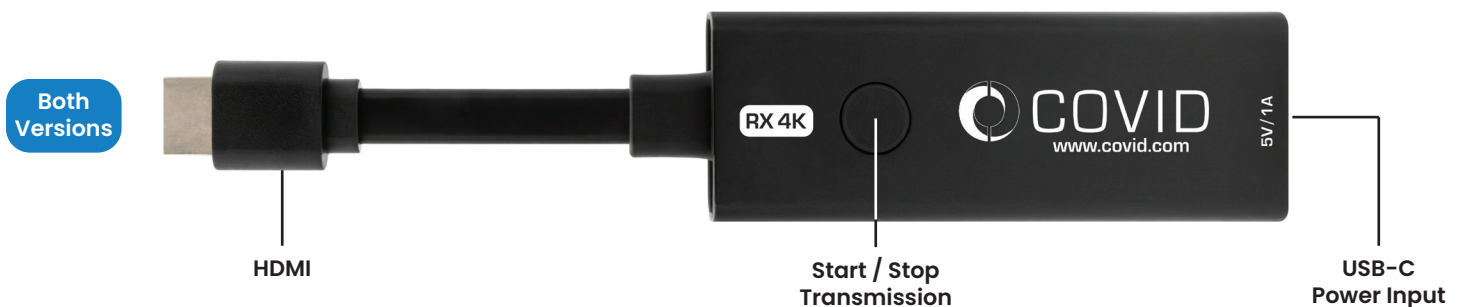

6. LED Meanings

| Tx LED Status | Status Description |
|-----------------|--|
| Solid Red | Tx is powering up |
| Flashing Red | Tx is connecting to Rx |
| Flashing Purple | Tx connected to Rx with no input signal detected |
| Flashing Blue | Tx connected to Rx with input signal detected, ready to cast |
| Solid Blue | Tx is connected to Rx with signal output |

| Rx LED Status | Status Description |
|---------------|--|
| Flashing Blue | Rx is powering up, ready to receive signal from Tx |
| Solid Blue | Rx received signal from Tx and outputting |

| | |
|-----------------------------|--|
| Unpair Tx from Rx | Long press Tx for 5 seconds and the LED will show a fast flashing red. This will unpair the Tx from the Rx. |
| Pair Additional Transmitter | Long press the Tx to unpair from the Rx. The Tx will automatically re-pair to the closer Rx once both Tx and Rx is power up. |

7. Operation Instructions

1. Install the Receiver

First, connect the Receiver to the HDMI port on the TV or monitor, and then connect power to the USB-C port with the included USB power cable by either a USB-A port on the display or a 5V / 1A wall adapter.

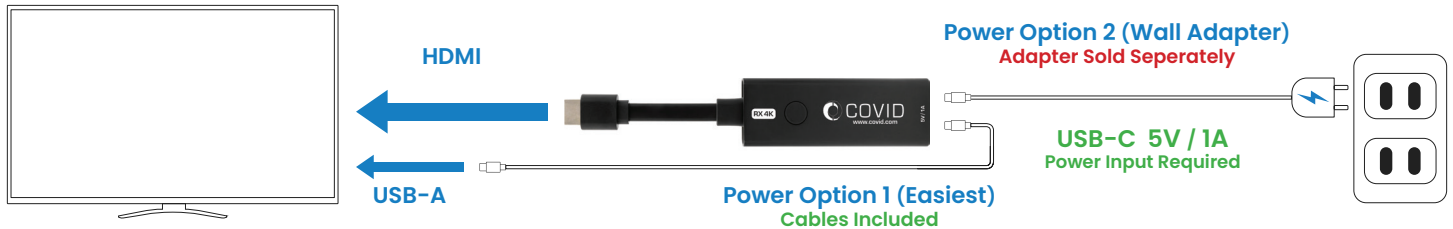

Note: If connection is dropping in and out, the RX is not receiving enough power from the display's USB port. **Recommended 1 Amp | Minimum 800mA**

2. Install the Transmitter

Second, connect the Transmitter to either the USB-C or HDMI port on the device you would like to transmit video from. Then, if extra power is needed, connect the included USB power cable to the device's USB-C port and the Type-A side of the cable to either a Type-A port on the device or a 5V / 1A wall adapter.

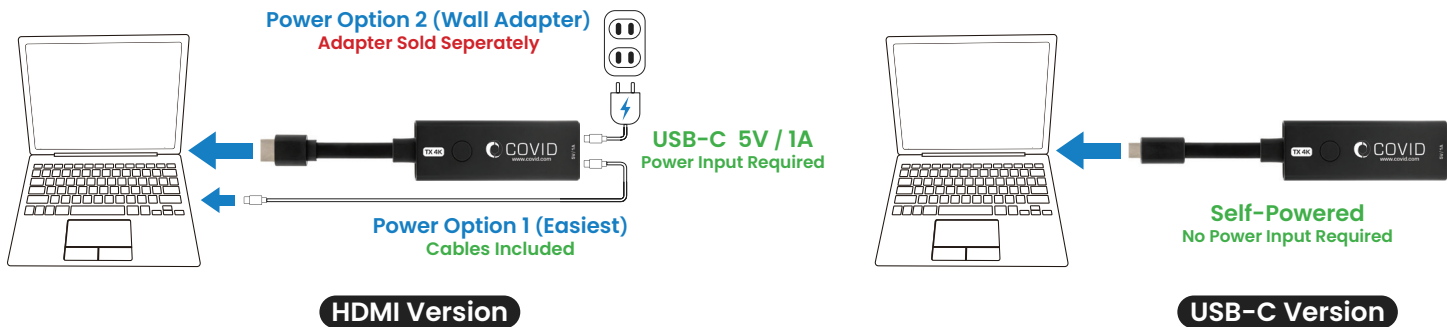

3. Stop and Restart the Transmission

The Transmitter will locate and connect to the Receiver automatically, and will begin transmitting video to the display. To stop the transmission, press the button on the Transmitter. To restart the transmission, press the button on the Transmitter again.



8. Pairing a New Extra Transmitter

You can purchase additional stand-alone transmitters **ECW-200-TX (USB-C)** or **EHW-200-TX (HDMI)**, and pair them with your receiver. The maximum amount of transmitters that can pair with one receiver is eight. To pair, simply follow the same instructions in section 7, steps 2 and 3 for each additional transmitter. To switch between which transmitter is currently active, press the button on the transmitter connected to the device you wish to send video from to the display.

9. How to Un-Pair TX from RX (A) and Re-Pair to RX (B)

- 1** Power on second RX (B) and connect to monitor

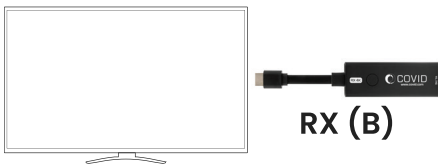

- 2** Power on TX and use pin to hold button for 2 sec

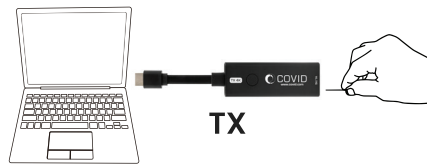

- 3** TX has been reset and is now unpaired from RX (A)

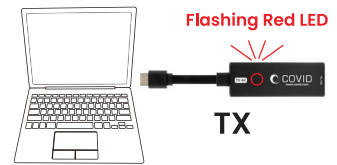

- 4** Auto pairing in progress, searching for nearest RX

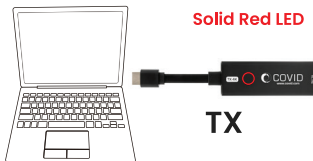

- 5** RX (B) found and is now attempting to connect

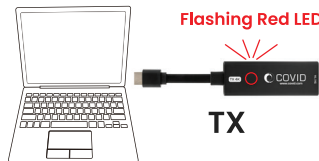

- 6** Devices are paired and are ready to stream

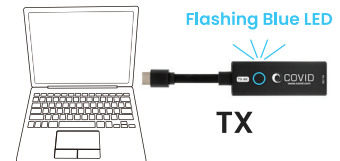

10. Adding a Custom Background Image

When the devices are idle and not streaming, an image will be displayed on screen. The stock image is an installation guide, but this image can be changed to anything you want it to be which can be useful in many scenarios. To do so, you will need your Receiver, a USB flashdrive, and the supplied USB-A Female to USB-A Male and USB-C Y-cable. To start, copy the image you wish to use onto your flashdrive and follow the connection diagram below.

Some important things to note:

- 🌀 USB flashdrive must be in FAT32 format
- 🌀 Image file must be in .jpg format
- 🌀 Image file name must be spelled "new_background.jpg" exactly without quotes
- 🌀 Image file must be less than 160KB in size
- 🌀 Image file must have a resolution of 1280x720 pixels

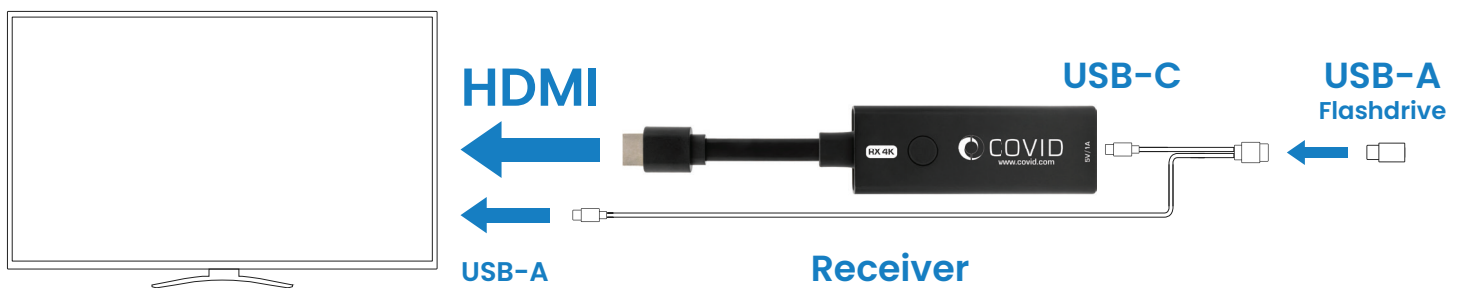

Note: Only connect the flashdrive once the RX is connected to the TV and is currently powered and showing up on screen.

Once you've plugged in the USB flashdrive a yellow message will display on screen letting you know that the image is updating and will reboot. Once rebooted, the display will now show your new custom image when your device is idle and not streaming. Repeat this process everytime you would like to have a different image on screen.

Note: If the RX appears on screen as out of range after updating the background image, please reboot the RX.

11. FCC Warning

Warning:

This device complies with Part 15 of the FCC Rules. Operation is subject to the following two conditions: (1) this device may not cause harmful interference, and (2) this device must accept any interference received, including interference that may cause undesired operation.

Changes or modifications not expressly approved by the party responsible for compliance could void the user's authority to operate the equipment.

NOTE: This equipment has been tested and found to comply with the limits for a Class B digital device, pursuant to Part 15 of the FCC Rules. These limits are designed to provide reasonable protection against harmful interference in a residential installation. This equipment generates uses and can radiate radio frequency energy and, if not installed and used in accordance with the instructions, may cause harmful interference to radio communications. However, there is no guarantee that interference will not occur in a particular installation. If this equipment does cause harmful interference to radio or television reception, which can be determined by turning the equipment off and on, the user is encouraged to try to correct the interference by one or more of the following measures:

- ☞ Reorient or relocate the receiving antenna.
- ☞ Increase the separation between the equipment and receiver.
- ☞ Connect the equipment into an outlet on a circuit different from that to which the receiver is connected.
- ☞ Consult the dealer or an experienced radio/TV technician for help.

SAR statement(Transmitter)

This device meets the government's requirements for exposure to radio waves. This device is designed and manufactured not to exceed the emission limits for exposure to radio frequency (RF) energy set by the Federal Communications Commission of the U.S. Government. The SAR limit set by the FCC is 1.6W/Kg. For body-worn operation, this device has been tested and meets the FCC RF exposure guidelines for use with an accessory that contains no metal and positions the device a minimum of 0mm from the body. RF exposure compliance with any body-worn accessory that contains metal was not tested and certified. and use of such body-worn accessory should be avoided. Accessory available in market and must be used to keep use distance 0mm from EUT to body-worn operation.

RF Exposure Statement (Receiver)

To maintain compliance with FCC's RF Exposure guidelines, This equipment should be installed and operated with minimum distance of 20cm the radiator your body. This device and its antenna(s) must not be co-located or operation in conjunction with any other antenna or transmitter.